

INSTRUCTION MANUAL

MA888

Digital Ethylene Glycol Refractometer





THANK YOU for choosing Milwaukee Instruments!

This instruction manual will provide you the necessary information for correct use of the meters.

All rights are reserved. Reproduction in whole or in part is prohibited without the written consent of the copyright owner, Milwaukee Instruments Inc., Rocky Mount, NC 27804 USA.

TABLE OF CONTENTS

1. FUNCTIONAL DESCRIPTION 5

2. GENERAL DESCRIPTION 7

3. SPECIFICATIONS 8

4. PRINCIPLE OF OPERATION 9

5. MEASUREMENT UNITS 11

6. MEASUREMENT GUIDELINES 11

7. CALIBRATION PROCEDURE 12

8. MEASUREMENT PROCEDURE 14

9. CHANGING MEASUREMENT UNIT 16

10. CHANGING TEMPERATURE UNIT 17

11. MAKING A STANDARD SOLUTION 18

12. ERROR MESSAGES 19

13. BATTERY REPLACEMENT 21

CERTIFICATION 22

RECOMMENDATION 22

WARRANTY 22

Remove the instrument from the packing materials and examine carefully to ensure no damage has occurred during shipping. If any damage has occurred, notify your Dealer.

Each instrument is supplied with:

- 9 V battery
- Instruction manual

Note: *Save all packing material until you are sure that the instrument functions correctly. A defective instrument must be returned in its original packing.*

1. FUNCTIONAL DESCRIPTION

DISPLAY

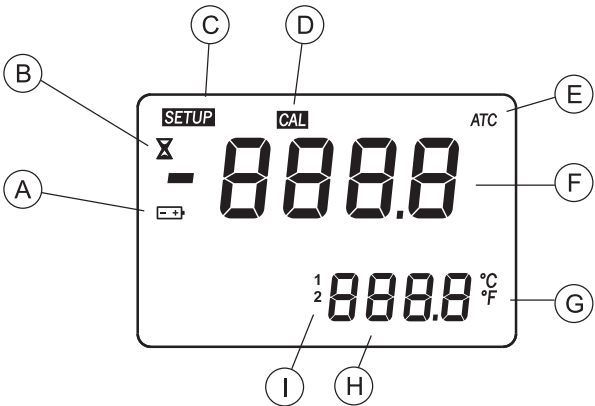

- A. BATTERY STATUS ICON
(BLINKS WHEN LOW BATTERY CONDITION DETECTED)
- B. MEASUREMENT IN PROGRESS TAG
- C. SETUP: FACTORY CALIBRATION TAG
- D. CAL: CALIBRATION TAG
- E. AUTOMATIC TEMPERATURE COMPENSATION
(BLINKS WHEN TEMPERATURE EXCEEDS 10-40 °C / 50-104 °F RANGE)
- F. PRIMARY DISPLAY
(DISPLAYS MEASUREMENT AND ERROR MESSAGES)
- G. TEMPERATURE UNITS
- H. SECONDARY DISPLAY
(DISPLAYS TEMPERATURE MEASUREMENTS;
WHEN BLINKING, TEMPERATURE HAS EXCEEDED OPERATION RANGE: 0-80 °C / 32-176 °F)
- I. RANGE INDICATOR

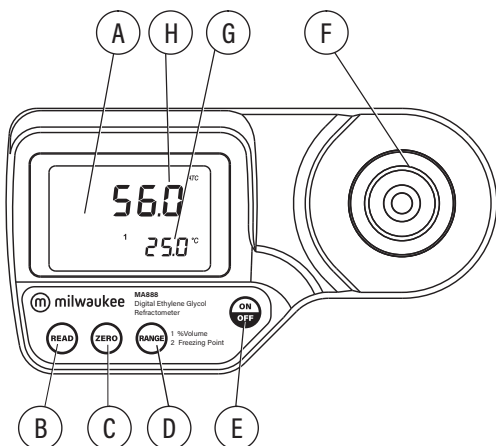
FRONT PANEL

- A. LIQUID CRYSTAL DISPLAY (LCD)
- B. READ KEY (USER MEASUREMENT)
- C. ZERO KEY (USER CALIBRATION)
- D. RANGE KEY (USER MEASUREMENT UNIT)
- E. ON/OFF
- F. STAINLESS STEEL SAMPLE WELL AND PRISM
- G. SECONDARY DISPLAY
- H. PRIMARY DISPLAY

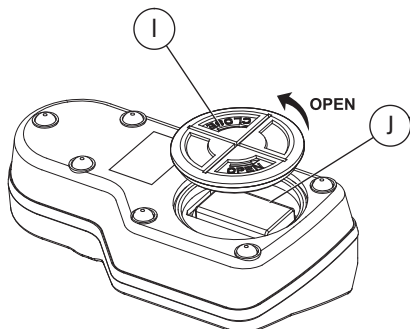
BOTTOM

- I. BATTERY COVER
- J. BATTERY COMPARTMENT

2. GENERAL DESCRIPTION

SIGNIFICANCE OF USE

Thank you for choosing Milwaukee. This instruction manual will provide you the necessary information for correct use of the meter.

The **MA888** is an optical instrument that employs the measurement of the refractive index to determine the % volume and freezing point of ethylene glycol based coolants or antifreeze. The digital refractometer eliminates the uncertainty associated with mechanical refractometers and is easily portable for use in the field to optimize your cooling system.

The **MA888** refractometer is an optical device that is simple and quick to use. Samples are measured after a simple user calibration with distilled or deionized water. Within seconds, the refractive index and temperature are measured and converted into one of two measurement units; % Volume or Freezing Point. The instrument utilizes internationally recognized references for unit conversion and temperature compensation for ethylene glycol solutions (e.g. CRC Handbook of Chemistry and Physics, 87th Edition).

The temperature (in °C or °F) is also displayed on the large dual level display along with helpful message codes.

Key features include:

- Waterproof models offers IP65 waterproof protection
- Automatic Temperature Compensation (ATC)
- Battery operation with Low Power indicator
- Automatically turns off after 3 minutes of non-use.

3. SPECIFICATIONS

	% Volume	Freezing Point	°C (°F)
Range:	0 to 100 %	0 to -50 °C (32 to -58 °F)	0 to 80 °C (32 to 176 °F)
Resolution:	0.1 %	0.1 °C (0.1 °F)	0.1 °C (0.1 °F)
Accuracy:	±0.2 %	±0.5 ° (±1.0 °F)	±0.3 °C (±0.5 °F)

Light Source	Yellow LED
Measurement Time	Approximately 1.5 seconds
Minimum Sample Volume	100 µL (cover prism totally)
Sample Cell	Stainless Steel ring and flint glass prism
Temperature Compensation	Automatic between 0 and 40 °C (32 to 104 °F)
Case Material	ABS
Enclosure Rating	IP 65
Battery Type/Life	1 x 9 volt AA batteries / 5000 readings
Auto-Shut off	After 3 minutes of non-use
Dimensions	19.2 x 10.2 x 6.7 cm (7.5 x 4 x 2.6")
Weight	420 g (14.8 oz.).

4. PRINCIPLE OF OPERATION

Ethylene Glycol determinations are made by measuring the refractive index of a solution. Refractive Index is an optical characteristic of a substance and the number of dissolved particles in it. Refractive Index is defined as the ratio of the speed of light in empty space to the speed of light in the substance. A result of this property is that light will "bend", or change direction, when it travels through a substance of different refractive index. This is called refraction.

When passing from a material with a higher to lower refractive index, there is a critical angle at which an incoming beam of light can no longer refract, but will instead be reflected off the interface.

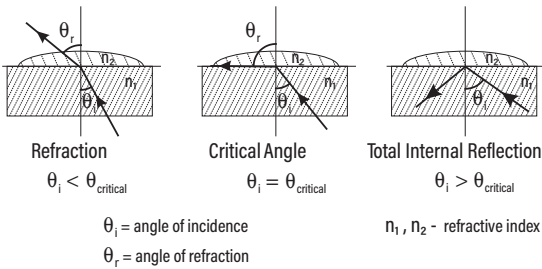

The critical angle can be used to easily calculate the refractive index according to the equation:

$$\sin(\theta_{critical}) = n_2 / n_1$$

Where n_2 is the refractive index of the lower-density medium; n_1 is the refractive index of the higher-density medium.

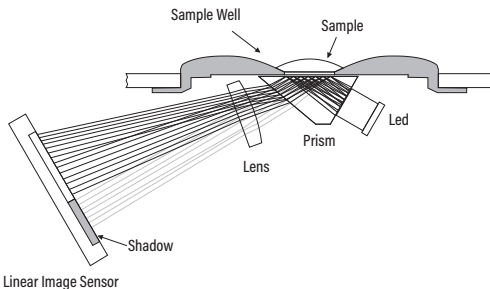

In the **MA888** refractometer, light from an LED passes through a prism in contact with the sample. An image sensor determines the critical angle at which the light is no longer refracted through the sample. Specialized algorithms then apply temperature compensation to the measurement and convert the refractive index to: %Volume or Freezing Point.

5. MEASUREMENT UNITS

Freezing point is displayed as a temperature from 0.0 to -50.0 °C corresponding to 0-58 % by volume. The display blinks the freezing point when the concentration of Ethylene glycol is greater than 78 % concentration by volume.

When the display shows "LO", the freezing point is at a minimum (below -50 °C).

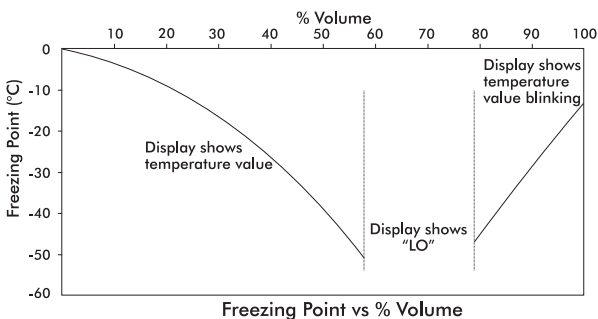

6. MEASUREMENT GUIDELINES

- Handle instrument carefully. Do not drop.
- Do not immerse instrument under water.
- Do not spray water to any part of instrument except the "sample well" located over the prism.
- The instrument is intended to measure ethylene glycol solutions. Do not expose instrument or prism to solvents that will damage it. This includes most organic solvents and extremely hot or cold solutions.
- Particulate matter in a sample may scratch the prism. Absorb sample with a soft tissue and rinse sample well with deionized or distilled water between samples.
- Use plastic pipettes to transfer all solutions. Do not use metallic tools such as needles, spoons or tweezers as these will scratch the prism.
- Cover sample well with hand if measuring in direct sun.

7. CALIBRATION PROCEDURE

Calibration should be performed daily, before measurements are made, when the battery has been replaced, between a long series of measurements, or if environmental changes have occurred since the last calibration.

1. Press the **ON/OFF** key, then release. Two instrument test screens will be displayed briefly; all LCD segments followed by the percentage of remaining battery life. The meter will then briefly display an indication of the measurement unit set. When the LCD displays dashes, the instrument is ready.

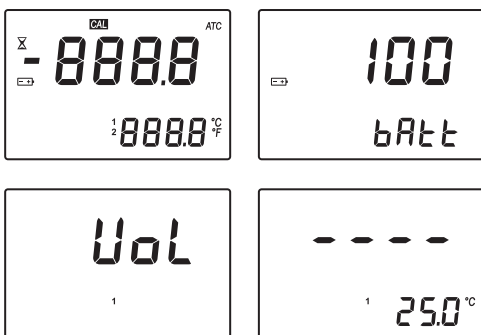

2. Using a plastic pipette, fill the sample well with distilled or deionized water. Make sure the prism is completely covered.

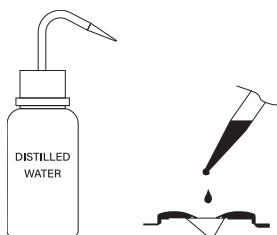

Note: If the ZERO sample is subject to intense light such as sunlight or another strong source, cover the sample well with your hand or other shade during the calibration.

3. Press the **ZERO** key. If no error messages appear, your unit is calibrated. (For a description of error messages see ERROR MESSAGES section).

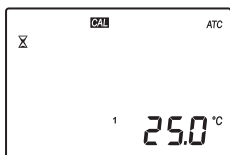

Note: The 0.0 screen will remain until a sample is measured or the instrument is turned off.

4. Gently absorb the ZERO water standard with a soft tissue. Use care not to scratch the prism surface. Dry the surface completely. The instrument is ready for sample measurement.

Note: If instrument is turned off the calibration will not be lost.



8. MEASUREMENT PROCEDURE

Verify the instrument has been calibrated before taking measurements.

1. Wipe off prism surface located at the bottom of the sample well. Make sure the prism and sample well are completely dry.



2. Using a plastic pipette, drip sample onto the prism surface. Fill the well completely.



Note: If the temperature of the sample differs significantly from the temperature of the instrument, wait approximately 1 minute to allow thermal equilibration.

3. Press the **READ** key. The results are displayed as % Volume or Freezing Point.

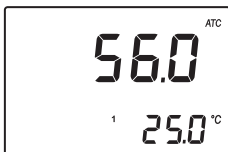

Note: The last measurement value will be displayed until the next sample is measured or the instrument is turned off. Temperature will be continuously updated.

Note: The "ATC" tag blinks and automatic temperature compensation is disabled if the temperature exceeds the 0-40 °C / 32-104 °F range.

4. Remove sample from the sample well by absorbing with a soft tissue.
5. Using a plastic pipette, rinse prism and sample well with distilled or deionized water. Wipe dry. The instrument is ready for the next sample.

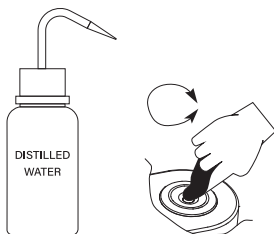

9. CHANGING MEASUREMENT UNIT

Press the **RANGE** key to select measurement units. The instrument toggles between the two measurement scales each time the key is pressed and the primary display indicates "**Vol**" % Volume or "**FrPt**" for Freezing Point. When the instrument displays the screen with 4 dashes, the instrument is ready for measurement. A number on the display indicates the selected unit: "**1**" denotes % Volume and "**2**" denotes Freezing Point (as indicated on the instrument cover).

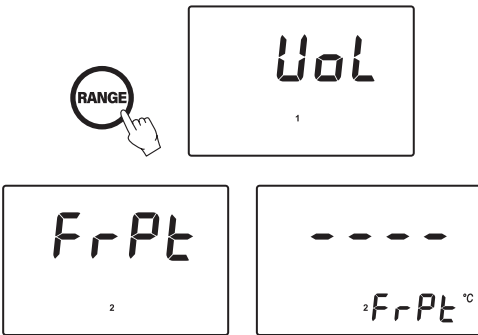

Note: The temperature measurement is not displayed in Freezing Point mode.

10. CHANGING TEMPERATURE UNIT

To change the temperature measurement unit from Celsius to Fahrenheit (or vice versa), follow this procedure.

1. Press and hold the **ON/OFF** key continuously for approximately 8 seconds. The LCD will display the "all segment" screen followed by a screen with the model number on the primary display and the version number on the secondary display. Continue pressing the **ON/OFF** key.



8 seconds

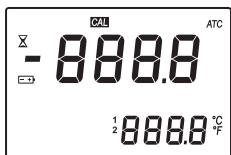

2. While continuing to hold the **ON/OFF** key, press the **ZERO** key. The temperature unit will change from °C to °F or vice versa.



°C or °F

Note: The selected unit will be used in Freezing Point mode.

11. MAKING A STANDARD SOLUTION

To make an Ethylene Glycol Solution, follow the procedure below:

- To make an X % ethylene glycol solution volumetrically add X mL of high purity ethylene glycol (CAS #: 107-21-1; MW 62.068) to a 100 mL Grade A volumetric flask.
- Use distilled or deionized water to bring the flask close to the total volume, mix, allow the solution to return to room temperature.
- Once the solution has returned to room temperature use distilled or deionized water to bring the total volume to 100 mL. Mix solution well before use.

	Ethylene Glycol	Total Volume	Expected Freezing Point Value
10 % V	10.00 mL	100.00 mL	-3.8 °C (25.2 °F)
40 % V	40.00 mL	100.00 mL	-26.3 °C (-15.4 °F)

12. ERROR MESSAGES

Error Code		Description
Err		General failure. Cycle power to instrument. If error persists, contact Milwaukee.
LO Primary display		Sample exceeds minimum measurement range.
HI Primary display		Sample exceeds maximum measurement range.
LO Primary display CAL segment ON		Wrong solution used to zero instrument. Use deionized or distilled water. Press Zero .
HI Primary display CAL segment ON		Wrong solution used to zero instrument. Use deionized or distilled water. Press Zero .
t LO Primary display CAL segment ON		Temperature exceeds ATC low limit (0 °C) during calibration.
t HI Primary display CAL segment ON		Temperature exceeds ATC high limit (40 °C) during calibration.
Air		Prism surface insufficiently covered.
ELt		Too much external light for measurement. Cover sample well with hand.
nLt		LED light is not detected. Contact Milwaukee.

Battery segment
blinking



<5% of battery life is
remaining.

Temperature values
are blinking **0.0°C**
or **80.0°C**

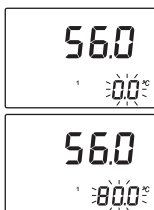

Temperature measurement
out of sampling range
(0 to 80°C).

ATC segment
blinking



Outside temperature
compensation range
(0 to 40°C).

SETUP segment
blinking

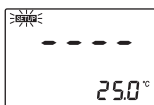

Factory calibration lost.
Contact Milwaukee.

13. BATTERY REPLACEMENT

To replace the instrument's battery, follow these steps:

- Turn the instrument OFF by pressing the **ON/OFF** key.



- Turn instrument upside down and remove the battery cover by turning it counterclockwise.

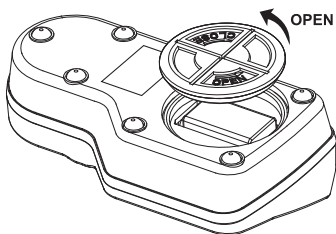

- Extract the battery from its location.
- Replace with fresh 9V battery making certain to observe polarity.
- Insert the back battery cover and fasten it by turning clockwise to engage.

CERTIFICATION

Milwaukee Instruments conform to the CE European Directives.



Disposal of Electrical & Electronic Equipment. Do not treat this product as household waste. Hand it over to the appropriate collection point for the recycling of electrical and electronic equipment.

Disposal of waste batteries. This product contains batteries. Do not dispose of them with other household waste. Hand them over to the appropriate collection point for recycling.



Please note: proper product and battery disposal prevents potential negative consequences for human health and the environment. For detailed information, contact your local household waste disposal service or go to www.milwaukeeinstruments.com (US only) or www.milwaukeeinst.com.

RECOMMENDATION

Before using this product, make sure it is entirely suitable for your specific application and for the environment in which it is used. Any modification introduced by the user to the supplied equipment may compromise the meter's performance. For your and the meter's safety do not use or store the meter in hazardous environment. To avoid damage or burn, do not perform any measurement in microwave ovens.

WARRANTY

This instrument is warranted against defects in materials and manufacturing for a period of 2 years from the date of purchase. Electrodes and Probes are warranted for 6 months. This warranty is limited to repair or free of charge replacement if the instrument cannot be repaired. Damage due to accidents, misuse, tampering or lack of prescribed maintenance is not covered by warranty. If service is required, contact your local Milwaukee Instruments Technical Service. If the repair is not covered by the warranty, you will be notified of the charges incurred. When shipping any meter, make sure it is properly packaged for complete protection.

Milwaukee Instruments reserves the right to make improvements in design, construction and appearance of its products without advance notice.

THANK YOU FOR CHOOSING



Sales and Technical Service Contacts:

Milwaukee Electronics Kft.
Alsó-kikötő sor 11C
H-6726 Szeged - HUNGARY
tel: +36 62 428 050
fax: +36 62 428 051
www.milwaukeeinst.com
e-mail: sales@milwaukeeinst.com

Milwaukee Instruments, Inc.
2950 Business Park Drive
Rocky Mount, NC 27804 USA
tel: +1 (252) 443-3630
fax: +1 (252) 443-1937
www.milwaukeeinstruments.com
e-mail: sales@milwaukeeinstruments.com

MANMA888